

USER MANUAL QUICK INSTALLATION GUIDE MGR350B



**BLUETOOTH® ENABLED
GAUGE HOLE RADIO**



FEATURING ZERO
STANDBY CURRENT DRAIN

USER MANUAL QUICK INSTALLATION GUIDE

MGR350B
BLUETOOTH® GAUGE HOLE RADIO

iPod® and iPhone® are registered trademarks of Apple Inc. registered in the USA and other countries. BOSS Audio Systems is not affiliated with Apple Inc.



BOSS Audio Systems
3451 Lunar Court • Oxnard, CA 93030



Copyright © 2015
PRINTED IN CHINA

Thank you for purchasing this



MGR350B Bluetooth Gauge Hole Radio
Please read through these instructions carefully so you will know how to operate your model properly.

After you have finished reading the instructions, keep this document in a safe place for future reference.

THIS PACKAGE CONTAINS

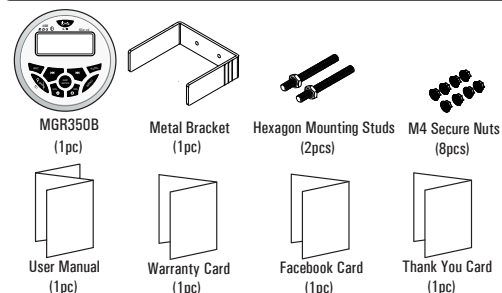

INFORMATION TO THE USER



The Bluetooth® word mark and logos are registered trademarks owned by Bluetooth SIG, Inc. and any use of such marks is under license. Other trademarks and trade names are those of their respective owners.

FCC COMPLIANCE STATEMENT

This device complies with part 15 of the FCC Rules. Operation is subject to the following two conditions:

- (1) this device may not cause interference, and
- (2) this device must accept any interference, including interference that may cause undesired operation of this device.

This transmitter must not be co-located or operated in conjunction with any other antenna or transmitter. The Bluetooth antenna cannot be removed (or replaced) by user. This equipment complies with FCC/IC radiation exposure limits set forth for an uncontrolled environment and meets the FCC radio frequency (RF) Exposure Guidelines and RSS-102 of the IC radio frequency (RF) Exposure rules. This equipment has very low levels of RF energy that it deemed to comply without maximum permissive exposure evaluation (MPE). But it is desirable that it should be installed and operated keeping the radiator at least 20 cm or more away from person's body (excluding extremities: hands, wrists, feet and ankles). Alteration or modifications carried out without appropriate authorization may invalidate the user's right to operate the equipment.

NOTE: This equipment has been tested and found to comply with the limits for a Class B digital device, pursuant to Part 15 of the FCC Rules. These limits are designed to provide reasonable protection against harmful interference in a residential installation. This equipment generates, uses and can radiate radio frequency energy and, if not installed and used in accordance with the instructions, may cause harmful interference to radio communications. However, there is no guarantee that interference will not occur in a particular installation. If this equipment does cause harmful interference to radio or television reception, which can be determined by turning the equipment off and on, the user is encouraged to try to correct the interference by one or more of the following measures:

- Relocate or reorient the receiving antenna.
- Increase the separation between the equipment and receiver.
- Connect the equipment into an outlet on a circuit different from that to which the receiver is connected.
- Consult the dealer or an experienced radio/TV technician for help.

!! WARNING !!

ADJUSTMENT OR ALTERATIONS OF THIS DEVICE MAY RESULT IN HAZARDOUS RADIATION EXPOSURE.

1

IMPORTANT SAFETY PRECAUTIONS

BE SURE TO OBSERVE THE FOLLOWING GUIDELINES:

- Do not turn up the volume so high that you can't hear what's around you.
- Use caution or temporarily discontinue use in potentially hazardous situations.
- Do not operate mobile video equipment while driving a motorized vehicle – safe driving and safety consideration of others should always be your highest priority.
- Set your volume control at a low setting, then slowly increase the sound until you can hear it comfortably without distortion, or ear discomfort.
- In the event you should notice smoke, strange noises or odor from this product, or any other abnormal signs, immediately turn off the power and consult your dealer or the nearest authorized **BOSS AUDIO Service Center**. Using this product in this condition may result in permanent damage to the system.

2

SUGGESTED MOUNTING METHODS

1 Make the mounting hole size as follows

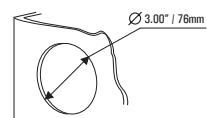

CAUTION!!
Using other mounting methods may void this warranty

2 Install studs mounts into rear of chassis

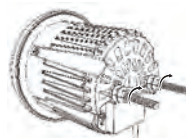

3 Adjust M4 nuts for the best mounting depth

4 Slip the unit through the hole cutout and into U-bracket

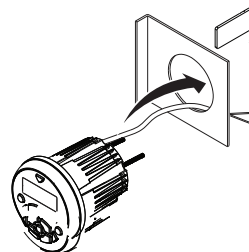

Snap off break-away tabs to best fit your applications depth



5 Firmly tighten remaining M4 nuts

6 Secure and waterproof the wiring



TOOLS NEEDED:

- Measuring Tape / Ruler
- Wrench and/or Pliers
- Hole Saw
- Crimp Tool

BEFORE YOU START

INSTALLATION PRECAUTIONS

Always consult with a professional installer

- Do not attempt to install or service this product by yourself. Installation or servicing of this product by persons without professional training and experience in electronic equipment and motorized vehicle accessories may be dangerous and could expose you to the risk of electric shock, injury or other hazards
- Refer any repairs to a qualified **BOSS AUDIO SYSTEMS Service Center**
- The **MGR350B** should be wired directly to a vehicles battery
- When wiring directly to the vehicles battery, be sure to disconnect the batteries negative terminal wire before starting any wiring procedures, if extending the main power primary wire, it is suggested that an optional fuse and fuse holder (not included) with minimum rating of 20 Amperes be in-line with the positive battery terminal
- The ground cable length should be as short as possible, if extending from you battery, be sure to use a proper gauge rating for the length of the run, use only high quality copper primary type wire
- The **MGR350B** has an IPX6 weather resistant design, it should not be submerged in or under water under any circumstances
- Do not use abrasive cleaning materials on the lens or bezel
- Use only the installation parts provided with the **MGR350B**

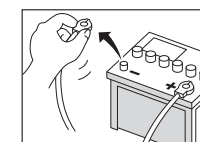

To avoid potential shorts in the electrical system, be sure to disconnect the (-) battery cable before installation. Use this unit with a 12-Volt battery and negative grounding only. Failure to do so may result in a fire or malfunction.



When replacing the fuse, be sure to only use a fuse of the rating specified on this product. To avoid short-circuiting, cover any disconnected leads with insulating tape. It is specially important to insulate any unused wires, which if left uncovered may cause a short circuit. When connecting other devices to this product, refer to the manual for the product to be connected. The black cable is ground, make sure to connect the ground wire first.

Ensure that the ground cable is properly connected to metal parts of the vehicles body frame or direct to the battery if your vehicle does not have a grounded chassis frame. The ground cable of this units power amp and a second powered system must be connected to the frame separately with different screws. If the screw for the ground wire loosens or falls out, it could result in fire or malfunction.

Ensure that the ground cable is properly connected to metal parts of the vehicles body frame or direct to the battery if your vehicle does not have a grounded chassis frame. The ground cable of this units power amp and a second powered system must be connected to the frame separately with different screws. If the screw for the ground wire loosens or falls out, it could result in fire or malfunction.

3

WIRE DIAGRAM

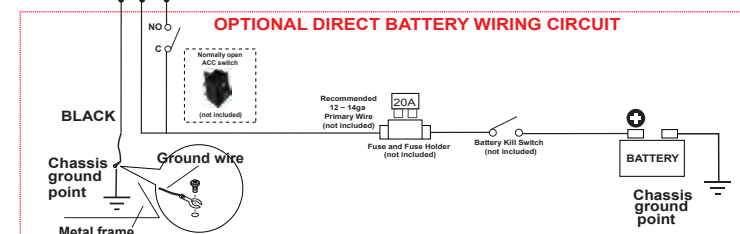
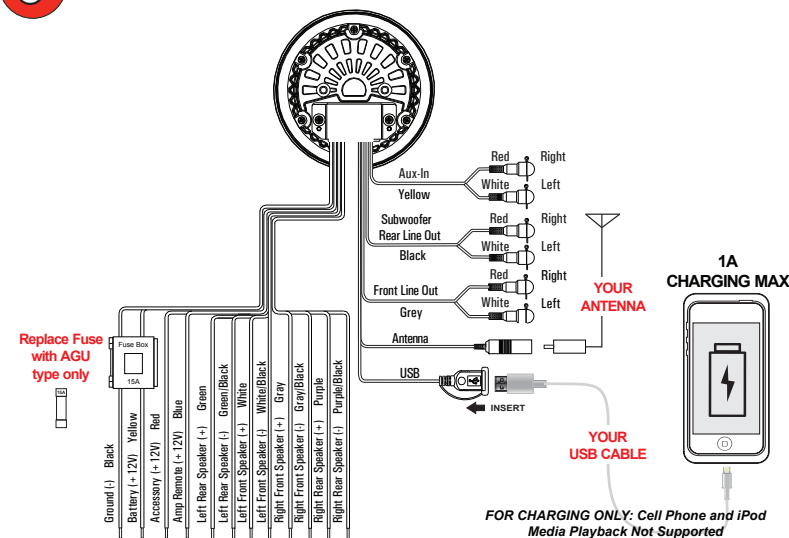

CAUTION!!
Do not ground or short the speaker leads

TROUBLE SHOOTING GUIDE

TROUBLE	CAUSE	SOLUTION
Unit will not turn on	The fuse is blown Ignition not engaged	Check / replace the fuse Turn ignition to on position
No sound is heard	Blown speaker Volume is low / muted	Replace faulty speaker Press the volume level up
	Device is paused or muted	Check your devices playing / volume status
Cannot pair Bluetooth	The Bluetooth function of the device is not enabled	Refer to the user manual of the device for how to enable the Bluetooth function
	The MGR350B BT memory is full	Follow how to reconnect a device in section E
The audio quality is poor after connection with a Bluetooth enabled device	The Bluetooth reception is poor	Move the device closer to the audio system or remove any obstacle between the device and the systems antenna
	Power glitch or interference	Disconnect power for 10 seconds to reset
Unit has become unresponsive	Low battery power	Charge battery, run the engine to recharge the battery
	Reset the main system	Follow steps in section B

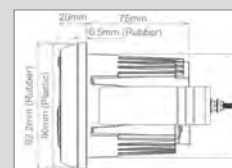

SPECIFICATIONS

- FM TUNER FREQUENCY RANGE**
 - USA 87.5-107.9MHz
 - Europe 87.5-108MHz
 - Asia 87.5-108MHz
 - Australia 87.5-108MHz
 - Usable Sensitivity: 12dB (S/N=30dB)
 - Bands: 2
- INTEGRATED AMPLIFIER**
 - MOSFET
 - MAX Continuous Output: 240W (All channels driven)
 - PEAK Power Rating: 60W / channel
 - RMS Total Power Output: 80W
 - Channels: 4
 - Class: AB
 - Frequency Response: 20-20kHz
 - 4Ω stable
- AM TUNER FREQUENCY RANGE**
 - USA 530-1710kHz
 - Europe 522-1620kHz
 - Asia 522-1620kHz
 - Australia 522-1620kHz
 - Usable Sensitivity: 40dB (S/N=20dB)
 - Bands: 1
- WEATHER BAND SELECTION**
 - CH.1 162.400MHz
 - CH.2 162.425MHz
 - CH.3 162.450MHz
 - CH.4 162.475MHz
 - CH.5 162.500MHz
 - CH.6 162.525MHz
 - CH.7 162.550MHz
 - Bands: 1
- GENERAL**
 - Power Source: 14.4VDC (10.8V ~ 16V allowable)
 - Grounding System: Negative type
 - Maximum Current Consumption: 15A
 - 3-way protection circuitry (thermal, overload, and speaker short protection)
 - Unit Weight: 1.08lbs / 0.52kg
 - Storage Temperature: -22°F to 176°F / -30°C to 80°C
 - Operation Temperature: -4°F to 158°F / -20°C to 70°C
 - Replacement Fuse: 15A

- BLUETOOTH**
 - BT: 3.0
 - BT Range: 33Ft / 10M (Class 2)
 - BT Profiles: A2DP / AVRCP 1.3
- USB DRIVE MEDIA SUPPORTED**
 - MP3
 - WMA
 - 65,000 Songs
 - 32GB / FAT 32
 - USB 2.0 High Speed
 - USB Output Voltage: 5VDC @ 1A

Specifications subject to change without notice

QUICK START GUIDE

A

GETTING STARTED



SOURCE MODES



	Short press to mute or restore volume. Turn the unit on, Press and hold again to turn the unit off. Press to pause, Press again to resume playback.
	Tuner/Weather Band Mode: Press to enter into the Manual Seek mode, press and hold to enter into the Auto Seek mode. Media Playback Mode: Press to TrackUp/Down, press and hold for FastForward/Rewind.
SRC	Press to scroll and select available Source.
PRESET Fn	Press to scroll and select Presets 1 ~ 6 Press and hold to enter into the Tuner Function modes: A-STORE / M-STORE / LOCAL / AREA / RDS / AF / TA / PTY
	Press to decrease the volume, press to increase the volume.
	Tuner/Weather Band Mode: To change different Band. Press and hold to access into Auto Store mode, the strongest stations of the selected band will be saved in preset channel automatically. FM1, FM2, AM1, WB1 Media Playback Mode: Press to access into search Folder/File music mode. Returns to the previous item.
BAND	
DISP ENTER	Tuner Mode: Press to view RDS receiver information. Media Playback: Press to view ID3 information.
AUDIO	Press to access into the Audio Menu mode for adjustments: EQ / XBASS / BASS / MIDDLE / TREBLE / BALANCE / FADER / REAROUT / SUBW / SUBW LPF / SUBW LEVEL Press and hold to access into the System Menu: BT RECONNECT / BEEP ON/OFF / ABOUT / RESET
MENU	

All rights reserved. No part of this publication may be reproduced, distributed, or transmitted in any form or by any means, including photocopying, recording, or other electronic or mechanical methods, without the prior written permission of BOSS AUDIO SYSTEMS Inc.

B

TUNER SETUP

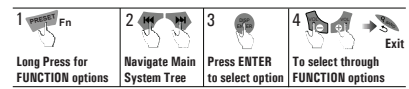
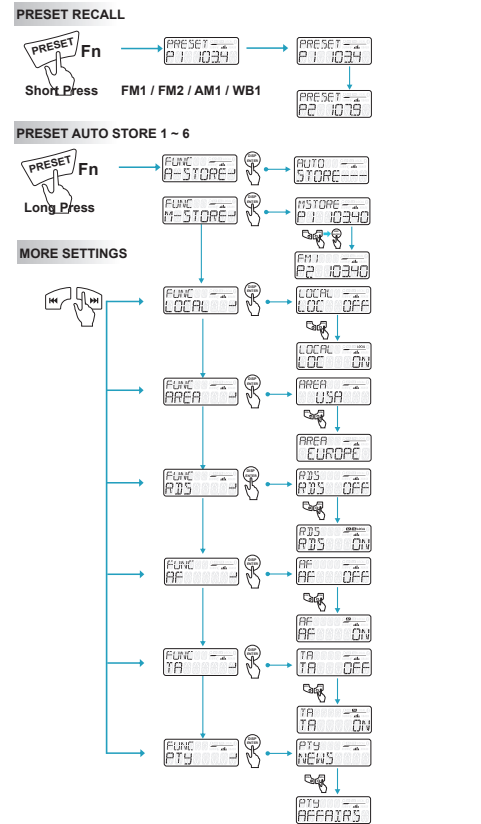

Media Playback Mode	Selectable settings
Repeat	ALL: to repeat all tracks on the storage media Song: the current track will be repeated Folder: repeats all tracks in the current folder
Random On/Off	This function allows you to play tracks/songs from the current album, songs or artists in a random order.
Tuner Mode	Selectable settings
Auto Store	Press to access into A-STORE mode, the strongest stations of the selected band will be saved in FM 1 or FM 2, AM 1 BAND presets automatically
Manual Store	When a desired radio station is set, press M-STORE to save it in the memory, you can store a total of 12 FM or 6 AM.
Local On/Off	ON: only stations with strong signal can be broadcast. The Local indicator will light up OFF: Stations of both strong and weak signals can be broadcast.
Area	Select suitable country area for this unit: USA / EUROPE / ASIA / AUST
RDS On/Off	Turn On or Off the RDS function.
AF On/off	ON: The unit will search for another station with stronger signal, but with the same program identification as the current station automatically. OFF: Turn off AF function
TA On/off	ON: When there is traffic announcement, unit will automatically switch to the tuner mode (regardless of the current mode) and begins to broadcast the announcement on traffic conditions. When the traffic announcement is over, unit will automatically return to the previous mode. OFF: Traffic announcement does not cut in.
PTY	Once inside the PTY mode, press the got into program type item, and rotat encoder volume knob to selected category. Available Program Type: POP M; ROCK M; EASY M; LIGHT M; CLASSICS; OTHER M; JAZZ M; COUNTRY; NATION M; OLDIES M; FOLK M; A-TEST; ALARM; NEWS; AFFAIRS; INFO; SPORT; EDUCATE; DRAMA; CULTURE; SCIENCE; VARIED; WEATHER; FINANCE; CHILDREN; SOCIAL; RELIGION; PHONE IN; TRAVEL; LEISURE; DOCUMENT

C

AUDIO and SYSTEM SETUP

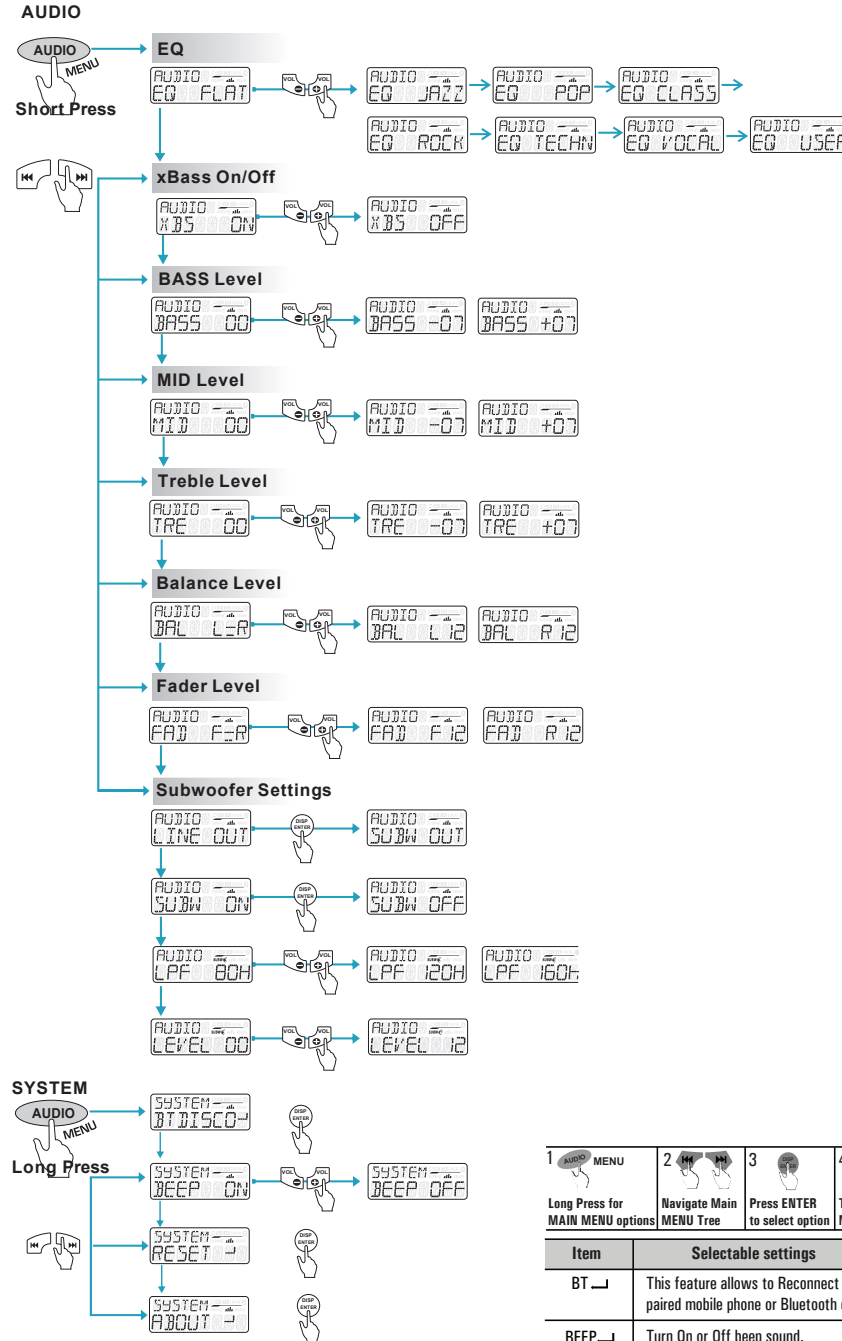

Tips: To avoid battery exhaustion be sure to run the vehicles engine while using this product. Using this product without running the engine can drain the battery.

D

RADIO OPERATION



- 1) Press the SRC button to select RADIO
- 2) Press to MUTE, press again to UNMUTE
- 3) To advance stations press
- 4) To skip previous stations press
- 5) Press the button to display RADIO information
- 6) Press the PRESET button to recall PRESETS 1 ~ 6

E

BLUETOOTH OPERATION



PAIRING & DISCOVERING A NEW BLUETOOTH CONNECTION

- 1) Power on the MGR350B by pressing and holding down the Power button for 1 second, the Bluetooth ICON will start to flash signalling that the MGR350B is now ready for Bluetooth pairing.
NOTE: You have 2 minutes before you must restart this procedure over again.
- 2) Now that the MGR350B is in pairing mode:

ANDROID users:

- a. Go into the Settings Menu of your ANDROID device
- b. Enter the Bluetooth Menu and press SCAN
- c. "BOSS MGR350" will now be display under AVAILABLE DEVICES
- d. If prompted, enter passcode: "0000"

IOS users:

- a. Go into the Settings Menu of your IOS device
- b. Enter the Bluetooth Menu
- c. "BOSS MGR350" will now be displayed
- d. If prompted, enter passcode: "0000"

- 3) If the MGR350B is not seen, repeat the above steps to refresh the "Device List"
- 4) When the BT connection is successful you will see BT CONNECTED message on the MGR350B LCD display, you are now ready to stream music from your devices favorite media player to the MGR350B

RECONNECTION

- 1) Power on the MGR350B and your last paired device Bluetooth
- 2) The unit will now automatically be reconnected
- 3) If your device was previously paired with the MGR350B, but it wasn't the last paired device:
 - a. Ensure no other devices are currently paired
 - b. Press and hold MENU button to manually connect / reconnect to the MGR350B
- 4) If the device is out of range from the MGR350B, it will disconnect automatically:
- 5) The MGR350B will reconnect to the device once in range, a confirmation message will be displayed on the LCD

F

BLUETOOTH STREAMING MUSIC



- 1) Press the SRC button to select BT AUDIO
- 2) Press to start PLAY, press again to PAUSE
- 3) To skip songs or advance tracks press , press and hold to FAST FORWARD
- 4) To select the previous track press the button , press and hold to FAST REWIND
- 5) Press the button to display song ID3 information

G

USB OPERATION



- 1) Press the SRC button to select USB
- 2) Press to start PLAY, press again to PAUSE
- 3) To skip songs or advance tracks press , press and hold to FAST FORWARD
- 4) To select the previous track press , press and hold to FAST REWIND
- 5) Press the button to display song ID3 information

H

AUX-INPUT

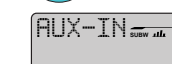

- 1) Press the SRC button to select AUX IN
- 2) Press to MUTE, press again to UNMUTE

Tips: Ensure to adjust the level of your devices master volume to 75%