

MR632UAB

BLUETOOTH® | FULLY MARINIZED
MP3-COMPATIBLE DIGITAL MEDIA
AM/FM RECEIVER

0318

BOSS®

AUDIO SYSTEMS



iPod® and iPhone® are trademarks of Apple, Inc. registered in the U.S. and other countries.
BOSS Audio Systems is not affiliated with Apple, Inc. or Google, Inc.
The Bluetooth® word mark and logos are registered trademarks owned by Bluetooth SIG, Inc. and any use of such marks
by BOSS Audio Systems is under license. Other trademarks and trade names are those of their respective owners.

USER'S MANUAL MR632UAB



BLUETOOTH® | FULLY MARINIZED
MP3-COMPATIBLE DIGITAL MEDIA
AM/FM RECEIVER



BOSS®

AUDIO SYSTEMS

CONTENTS

Precautions.....	1
Lithium Battery Cell Warnings	1
Use Cautions	1
Installation	2
Installation Procedures	2
Installation Opening.....	2
Wiring Connections.....	3
Uninstall the Main Unit	3
Control Panel Button Locations	4
Operation	4
Power / SRC	4
Change the Source (SRC)	4
Store/Recall Preset Stations (1 - 6).....	4
Play/Pause, Intro, Repeat, Random, Tracks playback.....	5
Track/Folder Navigation	5
Set the Clock (CLK)	5
Adjust Volume (VOL)	5
Switch Between US and EU Frequency.....	5
Manual Tuning (<< / >>)	5
Auto Seek Tuning (<< / >>).....	5
Next/Previous Track.....	5
Fast Forward/Backward	5
Change Bands (BAND).....	6
Automatic Music Search (AMS)	6
Track Search	6
Mute	6
Insert USB	6
AUX In Jack	6
Release Panel	6
Reset System (RESET)	7
Bluetooth Operation.....	7
Pair and Connect	7
Make a Call	7
Redial Last Dialed Number	7
Answer a Call.....	7
End a Call	7
Switch Audio Between Car and Phone	7
Adjust Talk Volume.....	7
Bluetooth Music (A2DP).....	7
Remote Control	8
Remove Insulating Sheet.....	8
Replace Lithium Battery Cell.....	8
Remote Control Operation	8
Button Names and Locations.....	9
Troubleshooting.....	10
Specifications	11

PRECAUTIONS

Lithium Battery Cell Warnings

- Cell leakage may cause damage to the remote control.
- Do not throw cells into fire, as this may cause an explosion.
- Keep battery cells out of reach of children.

Use cautions

- To reduce the risk of fire, electric shock, and annoying interference, do not repair yourself. Please refer serving to qualified person.
- Some MP3/WMA files may not be playable.
- Keep lower volumes to concentrate on traffic and road conditions for safety driving.
- If users' car is under sunlight for sometime, please lower the temperature inside the car then start the player operation.
- If the battery is disconnected or discharged or changed, the preset memory will be erased and must be reprogrammed.
- Installation of unit is better at a horizontal position, or if it is at an angle, it may be not working at its best situation.
- Never use force or grip the display and the buttons tightly when removing or attaching,
- Be sure to lower the volume before switching off the unit or the ignition key.

INSTALLATION

Installation Procedures

First complete the electrical connections and then check for correctness.

Installation Opening

This unit can be installed in any dashboard Having an opening as shown below.

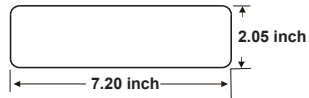

Insert mounting collar into the dashboard and bend the mounting tabs out with a screwdriver.

Make sure that lock lever(※) is flush with the mounting collar(not projecting outward).

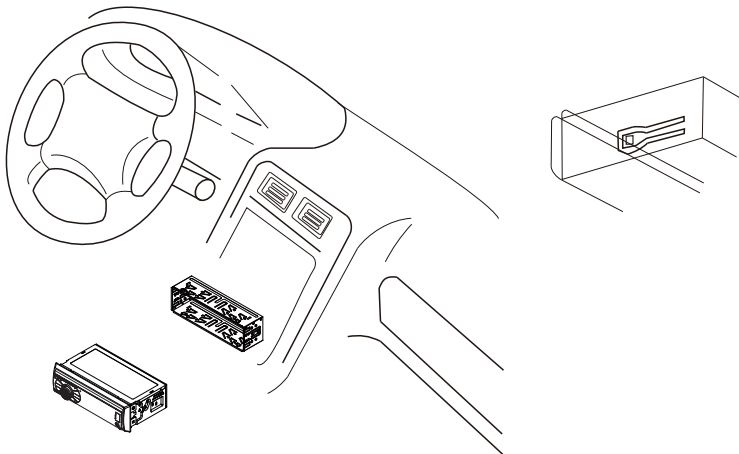
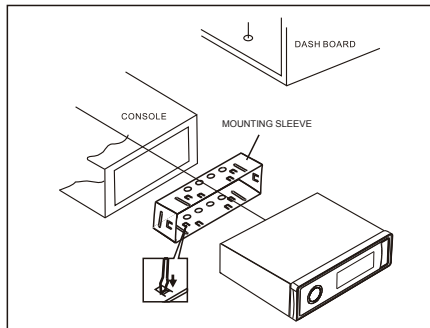

INSTALLATION(CONT.)



- Only use speakers with 4 ohms impedance.
- Do not attach the control panel to the chassis before wiring is complete.
- The maximum current of the Amp Remote trigger is 200mA.

Wiring Connections

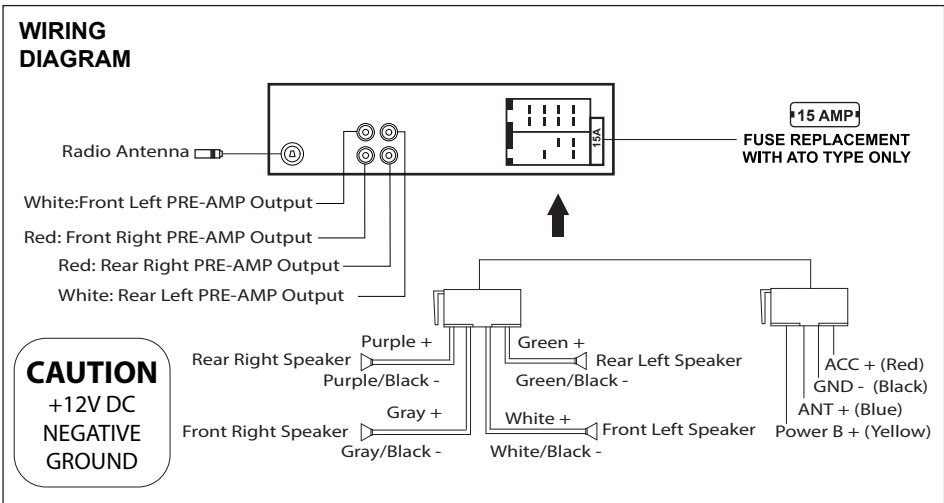

Uninstall the Main Unit

1. Remove the plastic trim out from the main unit.
2. Insert a bracket key into the left and right side of the main unit and draw the unit out of the mounting sleeve.

CONTROL PANEL BUTTON LOCATIONS

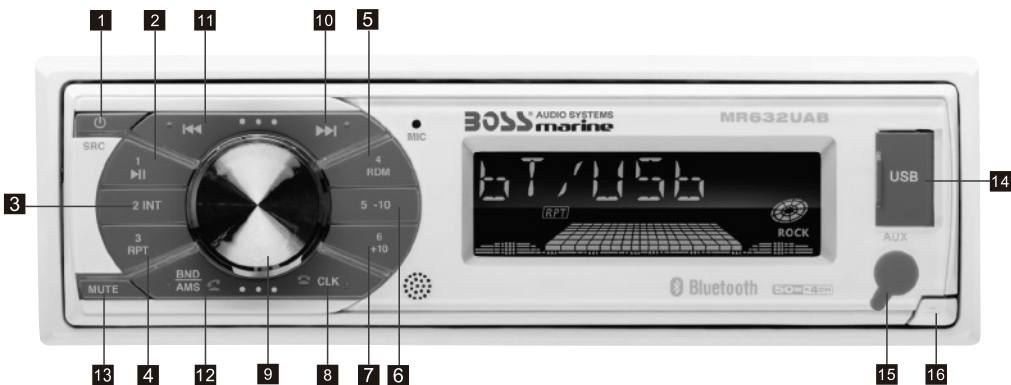

REMOVE PANEL



OPERATION

1.POWER/SRC

Press the POWER button to turn on the unit, and long press it again to turn off the unit. When the unit turns on, short press POWER/SRC button to switch the unit between RADIO, USB, BT, AUX IN, modes (if there are USB inside the unit).

1/. If there is no USB, then it will be only radio, BT and Aux. When the user inserts a USB flash driver, their respective logos will illuminate on the display.

2-7.(button 1 to 6) PRESET MEMORY BUTTONS In Radio mode

To memorize the frequency, press one of the six preset buttons (1-6) hold for more 2"S, the frequency is successfully stored.

Therefore there are FM1, FM2, FM3, AM1 & AM2, each band can store 6 stations, so total 30 stations can be stored.

To recall the preset memory station, press one of the preset buttons (1-6) plus the BND button for FM1, FM2, FM3, AM1 & AM2.

OPERATION

During USB mode, press the '1/▶||' button to pause or resume music playback.

Press the '2/INT' button to play the first 10 seconds of each track, press again to stop the introduction scan, and play the current track.

Press the '3/RPT' button to toggle between RPT ALL (Play all track), RPT FLR (Continuously repeats all tracks in current folder) and RPT ONE (Continuously repeats current track).

Press the '4/RDM' button to play all tracks in random order, press again to cancel random playback.

During USB mode, press '5/-10' button to go backward 10 tracks.

Press '6/+10' button to jump forward 10 tracks.

During USB mode, long press '5/-10' button to go back 1 folder.

Long press '6/+10' button to go up 1 folder. You can repeat this function depending on the number of folders. This button will have no function if the USB or SD card has no folders.

8. CLK

Press the CLK button once to display the real time, With time appearing on the display. Press and hold CLK button for more than 2 seconds until the hour flashes. You can adjust the HOUR by pressing the >>| button and |<< button. Then press the CLK button briefly, the minute will flash, you can adjust the MINUTE by pressing the >>| button and |<< button.

Finally press the CLK button to confirm the time adjustments.

9. VOLUME adjustment

Rotate the volume knob to increase or decrease the volume level of the sound output.

Press the SEL button on the front panel or on the remote control repeatedly to cycle through the following adjustable audio functions: BASS, TREBLE, BALANCE, FADER, EQ OFF, CLASS/ROCK/POP / FLAT, LOUD ON/OFF, DX/LOC, STEREO/MONO, CLOCK 12/24, AREA US/EU, ILL MID/HI/LOW.

• Rotate the VOL knob on the front panel or press the VOL+ ▲/VOL- ▼ button on the remote control to adjust the selected item.

- BASS: -7,-6, ~, -1,0,+1,~, +6,+7

- TREBLE: -7,-6, ~, -1,0,+1,~, +6,+7

- BALANCE: L7,L6,~, L1, 0, R1,~,R6,R7

- FADER: R7,R6~,R1,0,F1,~,F6,F7

- EQ(Equalizer) Setting: OFF, CLASS, ROCK, POP, FLAT

- Loudness: LOUD ON/OFF

- DX/LOCAL: Enables or disables the local broadcast mode (LOCAL).

- Stereo/Mono: Switches between MONO and STEREO reception mode for radio frequencies.

- CLOCK 12/24: Select between 12 hours and 24 hours display.

Note: If 12 hour display is selected, AM= Morning; PM= Afternoon

- AREA US/EU: This car radio is equipped the USA / Europe frequency.

Rotate the volume knob to switch between USA and Europe frequency.

The system will change the frequency setting in about 3 seconds.

- ILL MID/HI/LOW: This receiver is equipped with 3 brightness settings.

Rotate the volume knob to preset the illumination to middle, high or low.

OPERATION

10.FF(>>|) & 11.FB(|<<)

In the radio mode:

Long press the >>| or |<< button for more than 2 seconds, the unit will switch to manual tuning mode, briefly press the >>| or |<< button to search the next or previous frequency step by step.

Short press the >>| or |<< button, the automatic search will start, it will search upward or downward for the strong signal radio station within the current band. The auto searching will stop until find a station.

In the USB mode:

Briefly press the >>| or |<< button to play the the next or previous track.

Press and hold the >>| or |<< button to fast forward or fast backward.

12.BND/AMS

In radio mode,short press the BND/AMS button repeatedly to select the one of the radio band : FM 1, FM 2,FM 3, AM1,AM2 in a cycle sequence. When you select a band, the word F1、 F2、 F3 for FM band, and A1, A2 for AM band will be shown on the LCD display.

Press the BND/AMS button for several seconds,the radio searches form the current frequency and check the signal strength until one cycle search is finished. When the 6 strongest stations will be stored into the corresponding preset number within the current band.Short press the AMS button on the remote control to scan each preset station in each band.

During USB playback, press and hold the BND/AMS button to enter track search mode, the "TRK0000" will appear on the display. Rotate VOL knob to select the "first number". Then press the |<< button to move the "first number" to the left and enter the next number. Finally press the SEL button to confirm and play the selected track. If no any operation in 5 seconds,it will play the current track.



13. MUTE

Short press the MUTE button to turn MUTE ON/OFF, when it is on, the MUTE will be flash on the LCD and no sound output. When short press again it will be cancelled.

14. USB PORT

15. AUX IN JACK

16.

If you want to reset the unit, remove the front panel from the head unit, press the  button to detach the press the  button to detach the front panel.

17. RESET

To reset all parameters to factory default values. Press the  button to detach the control panel form the head unit and remove the control panel,then use a subject with a sharp point end to thrush the RESET hole.



BLUETOOTH OPERATION

Pair and Connect

Prior to using the Bluetooth device as a handsfree system for a Bluetooth-enabled mobile phone for the first time, you must pair and connect the two devices as follows:

1. In any mode, prior to pairing and connecting, the BT logo flashes in the LCD indicating that no device is connected. To begin pairing, enable BT mode on your mobile phone.
2. When the phone finds the car audio system, the “BOSS MR632UAB” will be displayed.
3. Choose the “BOSS MR632UAB” from the device list to pair and connect with the car audio system. Upon confirming, the BT logo will stop flashing.
4. When pairing is complete, the mobile phone audio will automatically transfer to the car audio system whenever a call is made or received, or when the mobile phone plays music.

Make a Call

- To make a call, dial the call directly from the paired mobile phone.
- To make a call with this Bluetooth handsfree system.
 - a) When linking up the Bluetooth mobile phone to this car audio handsfree system, press the  button to access the dial telephone number mode, then press the “0~9”, * and # button on the remote control to input the telephone number, the entered number will be shown on the LCD.
 - b) If a number has been incorrectly input, press the **DEL** button or  button to delete it.
 - c) Press the  button to make outgoing call.

Redial Last Dialed Number

Press and hold the  button on the control panel to redial the last dialed phone number.

Answer a Call

- When the mobile phone is called, the incoming telephone number displays in the LCD.
- To receive the call, press the  button on the control panel or remote control.

Reject or End a Call

To reject the call or end an active call, press the  button.

Switch Audio Between Car and Phone

During a call, press the **VOL** knob/button to switch the audio source from the car audio system back to your mobile phone.

Adjust Talk Volume





- During a call, use **VOL** knob or **VOL +** and **VOL -** buttons to adjust the volume level.
- Use the **MUTE** button to mute sound.

Audio Streaming (A2DP)

1. Press the /SRC button to enter BT mode and display pause in the LCD.
2. When a mobile device is paired, music played through that device will automatically be heard through the car audio system.
3. Press the >>| or |<< button to play the next or previous song/file on the mobile phone.
4. Press the >|| button to pause or resume music playback.

REMOTE CONTROL

Button Names and Locations

1.  (Power on/off) button
2. VOL+/VOL-(volume increase/decrease) button
3. Band button,  (answer call) button
4. PREV: tune down, seek down;
Previous Track, fast reverse
5. SEL(selection) button
6. NEXT: tune up, seek up; Next Track, fast forward
7. Mute button, DEL(Delete) button
8. CLK(clock setting) button,  (end call) button
9.  button, preset station 1 button, keypad 1
10. INT(intro) button, preset station 2 button, keypad 2
11. RPT(repeat) button, preset station 3 button,
keypad 3
12. RDM (random), preset station 4 button, keypad 4
13. -10(previous 10 tracks), preset station 5 button,
keypad 5
14. +10(next 10 tracks), preset station 6 button,
keypad 6
15. ST(stereo) button, keypad 7
16. LOUD(loudness) button, keypad 8
17. AMS(automatic music search) button, keypad 9
18. SRC(Source) button, keypad *
19. EQ(Equalizer) button, keypad 0
20. LOC(local)/DX button, keypad #

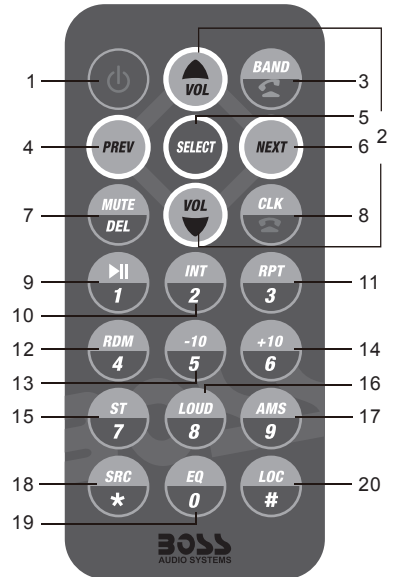

Note: When using the remote control for the first time, you must pull out the protective plastic tab from the battery compartment found on the back of the remote control.

REMOTE CONTROL

Remove Insulating Sheet

The remote control comes with an insulating sheet attached to the underside of the remote control, as illustrated on the right. The remote control will not work until the insulating sheet is removed.

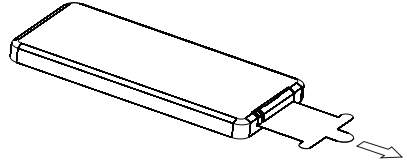

Replace Lithium Battery Cell

1. When the lithium cell battery becomes weak, replace it as illustrated on the right.
2. Press and hold the movable block in the direction indicated by arrow 1. At the same time, pull the cell holder out of the remote control in the direction indicated by arrow 2.
3. Replace the old cell with a new one, making sure the (+) polarity is facing upward.
4. Re-insert the cell holder into the remote control.

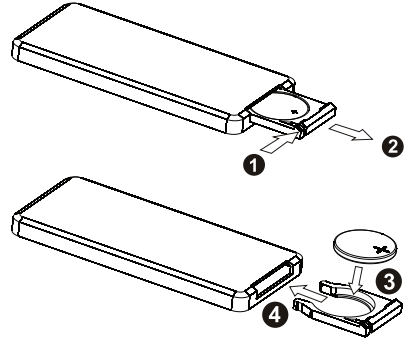

- Cell leakage may cause damage to the remote control.
- Do not throw cells into fire, as this may cause an explosion.
- Keep battery cells out of reach of children.

Remote Control Operation

Position the emitting window of the remote control toward the sensor window of the unit.

- The operation angle for front panel remote control reception is about 30 degrees.
- The distance between the emitting window of the remote control and the sensor window of the unit should remain less than 5 meters.

TROUBLESHOOTING

If you suspect something is wrong, immediately switch power off. Do not use the unit in abnormal condition, for example without sound, or with smoke or foul smell, can cause fire or electric shock.

Immediately stop using it and call the store where you purchased it. Never try to repair the unit by yourself because it is dangerous to do so.

■ General

1) Car's engine switch is not on.

Turn you car's key to ACC or ON.

2) Cable is not correctly connected.

Check the connection.

3) Fuse is burnt.

Replace fuse.

4) Volume is in mute or minimum.

Check volume or mute on/off, adjust volume to a desired level.

5) Sound skips.

The installation angle is more than 30°. Adjust the installation angle less than 30°.

6) The operation keys do not work.

The built-in micro- computer is not operating properly due to noise. Press the RESET button to restore the program to zero.

■ Radio

1) Much noise in broadcasts.

Station or signal is too weak. Select other stations of stronger signal level.

2) The antenna cable is not connected.

Insert the antenna cable firmly into the antenna socket of this car radio.

3) Preset station is reset.

Battery cable is not correctly connected. Connect the battery cable to the terminal that is always live.

■ USB

USB is connecting but no sound

a) USB connection is not good. Take it out and insert again.

b) USB is damaged or no music file inside. Change to another USB, or record music inside it.

SPECIFICATIONS

General

Power supply Requirement :	DC 12V
Maximum power output :	50W X 4CH
Speaker impedance :	4 - 8 Ohm
Unit Dimensions(WxHxD) :	7.0 X 2.0 X 3.8 inch
Weight :	1.54 Lb (0.7 kg)
Fuse :	15 A

RADIO

FM

Frequency Range USA / EUROPE:	87.5 MHz - 107.9 MHz / 87.5 MHz - 108.0MHz
Channel step:	200 KHz / 50 KHz

AM

Frequency Range USA / EUROPE:	530 KHz - 1710 KHz / 522-1620 KHz
Channel step:	10 KHz / 9 KHz

USB

Usable Audio Formats :	MP3/WMA
USB Port Type:	2.0
USB Charging:	5V/1A
Pre-amp Output:	Front and Rear
Frequency Response :	20 Hz - 20 KHz
S/N Ratio :	60dB

BT

BT Profile supports:	Headset, Handsfree and A2DP & AVRCP
Range of frequency:	2.4GHz spectrum